



Perfecting the Air



INVERTER AIR COOLED PACKAGED AIR CONDITIONERS

FLOOR STANDING TYPE
DUCT TYPE



R-410A

COOLING ONLY 50Hz



DIRECT AIR BLOW DUCT CONNECTION

FLOOR STANDING TYPE

DUCT TYPE

OUTDOOR UNIT

Inverter Packaged Air Conditioner Line Up for Factories and Offices

Product Line Up **R-410A**

RZUR-P Series

Cooling only

50Hz

Capacity	kW Btu/h	20.5 70,000	26.4 90,000	
FLOOR STANDING TYPE (DIRECT AIR BLOW) Specifications Page 7		 FVGR08PV25R1	 FVGR10PV25R1	
OUTDOOR UNIT		 RZUR08PY25	 RZUR10PY25	

RZUR-Q Series

Cooling only

Enhanced lineup

Wider capacity range with 2 new lineups of 12 and 20 HP

50Hz

Capacity	kW Btu/h	23.2 79,000	28.9 99,000	34.7 ^{New} 118,000	46.3 159,000	52.0 177,000	57.7 ^{New} 197,000
FLOOR STANDING TYPE (DUCT CONNECTION) Specifications Page 7			 FVPR10QY2S	 FVPR12QY2S	 FVPR16QY2S	 FVPR18QY2S	 FVPR20QY2S
DUCT TYPE Specifications Page 8		 FDR08QY2S	 FDR10QY2S	 FDR12QY2S	 FDR16QY2S	 FDR18QY2S	 FDR20QY2S
OUTDOOR UNIT		 RZUR08QY2S	 RZUR10QY2S	 RZUR12QY2S	 RZUR16QY2S	 RZUR18QY2S	 RZUR20QY2S

DIRECT AIR BLOW

Direct air blow from indoor unit with plenum

- Comfortable factory air conditioning using multiple indoor units installed in accordance with the space.
- Installation is next to walls, so units will not affect the factory layout even if the changes are made.

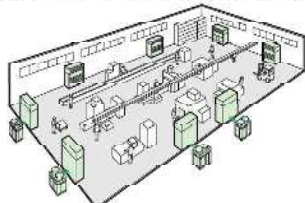

DUCT CONNECTION / DUCT TYPE

Air blow via connected ducts

- Comfortable air conditioning of the entire factory by connecting a blow duct at the top of the indoor unit.

Note: Ducts to be procured locally.

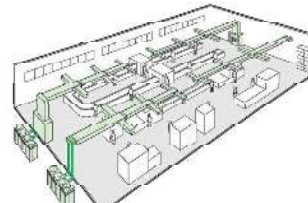

Electricity Cost compare with Non-Inverter model

Electricity cost/year reduce **35%** averagely

SBU	Non-inverter		Inverter		Diff Electric cost/year	% Reduce
	Model	Electric cost / Year	Model	Electric cost / Year		
Duct	AFDR08NY1	102,578 THB	FDR08QY2S	62,269 THB	40,309 THB	39%
	AFDR10NY1	130,548 THB	FDR10QY2S	76,572 THB	53,976 THB	41%
	AFDR13NY1	170,170 THB	FDR12QY2S	96,565 THB	73,605 THB	43%
	AFDR15NY1	204,374 THB	FDR16QY2S	129,942 THB	74,432 THB	36%
	AFDR18NY1	243,841 THB	FDR18QY2S	175,380 THB	68,461 THB	28%
	AFDR20NY1	286,536 THB	FDR20QY2S	196,884 THB	89,652 THB	31%
Floor Direct blow	AFVR08NV1	98,069 THB	FVGR08PV2SR1	69,839 THB	28,230 THB	29%
	AFVR10NV1	128,057 THB	FVGR10PV2SR1	79,332 THB	48,725 THB	38%
Floor Duct Connection	AFPR10NY1	130,548 THB	FVPR10QY2S	82,238 THB	48,310 THB	37%
	AFPR13NY1	169,449 THB	FVPR12QY2S	120,217 THB	49,232 THB	29%
	AFPR15NY1	203,597 THB	FVPR16QY2S	140,214 THB	63,383 THB	31%
	AFPR18NY1	240,903 THB	FVPR18QY2S	161,666 THB	79,238 THB	33%
	AFPR20NY1	282,894 THB	FVPR20QY2S	179,508 THB	103,386 THB	37%

*Electric cost refer calculation method from ISO16358-1:2013 same method as EGAT Air Conditioning No 5 Label (Operating 8hr/day, Electric cost 3.96Baht/unit), Calculation base on same capacity(BTU/h)



Specifications

FLOOR STANDING TYPE

DIRECT AIR BLOW

Model Name	Indoor unit		FVGR08PV2SR1		FVGR10PV2SR1	
	Outdoor unit		RZUR08PY2S		RZUR10PY2S	
Rated cooling capacity ¹⁾ (Min-Max.)	Dtu/h		70,000 (22,900-74,000)		90,000 (19,100-96,000)	
	kW		20.5 (6.7-21.7)		26.4 (5.6-28.1)	
Power consumption ¹⁾	kW		7.65		9.36	
SEER			13.08		14.43	
COP			2.68		2.82	
Indoor unit	Power supply		1 Phase, 220 V, 50 Hz			
	Colour		Ivory White			
	Air flow rate (H/L)		m ³ /min		80/65	
			cfm		2,830/2300	
	Fan	Motor output	kW		0.215~2	
		Drive	Direct Drive 2-Speed			
	Dimensions (H×W×D)		mm		1,870×1,170×510	
Machine weight		kg		149		
Sound level		dB(A)		61/57		
Drain		mm		PS 10 Internal thread		
Outdoor unit	Power supply		3 Phase, 380 V, 50 Hz			
	Colour		Ivory white			
	Compressor	Type	Hermetically sealed scroll type			
		Motor output	kW		3.4×1	
	Coil type		Cross Fin Coil			
	Air flow rate (H)	m ³ /min		178		
	Dimensions (H×W×D)		mm		1,657×930×765	
Machine weight		kg		175		
Sound level ²⁾		dB(A)		56		
Operation range		°CDB		10 to 49		
Refrigerant charge		kg		5.9		
Refrigerant Piping	Liquid	mm		Ø 9.5 (Brazing)		
	Gas	mm		Ø 19.1 (Brazing)		
Max. piping length	m		70 (equivalent length 90 m)			
Max. level difference	m		50			
Safety Device		High Pressure Switch, Fan Driver Overload Protector, Overcurrent Relay, Inverter Overload Protector				

DUCT CONNECTION

Model Name	Indoor unit		FYPR10QY2S	FYPR12QY2S	FYPR16QY2S	FYPR18QY2S	FYPR20QY2S	
	Outdoor unit		RZUR10QY2S	RZUR12QY2S	RZUR16QY2S	RZUR18QY2S	RZUR20QY2S	
Rated cooling capacity ¹⁾ (Min-Max.)	Dtu/h		99,000 (21,000-100,000)	118,000 (45,000-120,000)	158,000 (44,000-160,000)	177,000 (47,000-180,000)	197,000 (47,000-200,000)	
	kW		29.00 (6.1-29.30)	34.70 (13.3-35.20)	46.30 (12.9-46.90)	52.00 (13.7-52.90)	57.70 (13.7-59.60)	
Power consumption ¹⁾	kW		10.90	12.39	15.70	20.00	25.42	
SEER			13.92	11.35	13.03	12.66	12.69	
COP			2.65	2.80	2.95	2.60	2.27	
Indoor unit	Power supply		3 Phase, 380 V, 50 Hz					
	Colour		Ivory White					
	Air flow rate (H)		m ³ /min		80		120	
			cfm		2,830		4,240	
	External static pressure ³⁾		Pa		147		150	
	Fan	Motor output	kW		1.6		2.2	
		Drive	Belt Drive					
Dimensions (H×W×D)		mm		1,740×1,170×510		1,870×1,470×720		
Machine weight		kg		151		251		
Sound level		dB(A)		61		67		
Drain		mm		PS 10 Internal thread				
Outdoor unit	Power supply		3 Phase, 380 V, 50 Hz					
	Colour		Ivory white					
	Compressor	Type	Hermetically sealed scroll type					
		Motor output	kW		4.5×1		(3.5×1)+(3.5×1)	
	Coil type		Cross Fin Coil					
	Air flow rate (H)	m ³ /min		178		257		
	Dimensions (H×W×D)		mm		1,657×930×765		1,657×1,240×765	
Machine weight		kg		185		260		
Sound level ²⁾		dB(A)		57		60		
Operation range		°CDB		10 to 49				
Refrigerant charge		kg		6.7		8.2		
Refrigerant Piping	Liquid	mm		Ø 9.5 (Brazing)		Ø 12.7 (Brazing)		
	Gas	mm		Ø 22.2 (Brazing)		Ø 28.6 (Brazing)		
Max. piping length	m		70 (equivalent length 90 m)					
Max. level difference	m		50					
Safety Device		High Pressure Switch, Fan Driver Overload Protector, Overcurrent Relay, Inverter Overload Protector						

Note: 1. Indoor temp: 27°CDB, 19°CWB / outdoor temp: 35°CDB, 24°CWB / Equivalent piping length: 7.5 m, level difference: 0 m.

2. Anechoic chamber conversion value, measured at a point 1 m in front of the unit at a height of 1.5 m. During actual operation, these values are normally somewhat higher as a result of ambient conditions and oil recovery mode. When there is concern for noise the surrounding area such as residences, we recommend investigating the installation location and taking soundproofing measures.

3. The value is the external static pressure with standard pulley.

4. Capacity are net, including a deduction for cooling for indoor fan motor heat

DUCT TYPE

Model Name	Indoor unit		FDR08QY2S	FDR10QY2S	FDR12QY2S	FDR16QY2S	FDR18QY2S	FDR20QY2S
	Outdoor unit		RZUR08OY2S	RZUR10OY2S	RZUR12OY2S	RZUR16OY2S	RZUR18OY2S	RZUR20OY2S
Rated cooling capacity ^{1,2} (Min-Max.)	Btu/h		79,000 (1,000-80,000)	99,000 (2,000-100,000)	118,000 (45,000-120,000)	158,000 (44,000-160,000)	177,000 (47,000-180,000)	197,000 (47,000-200,000)
	kW		23.20 (3.1-23.50)	28.90 (6.1-29.30)	34.70 (15.5-35.20)	46.30 (12.9-46.90)	52.00 (15.7-52.80)	57.70 (15.7-58.60)
Power consumption ^{1,3}	kW		8.92	10.70	11.19	15.69	21.22	26.39
SEER			14.67	14.95	14.13	14.06	11.67	11.57
COP			2.60	2.70	3.10	2.95	2.45	2.19
Indoor unit	Power supply		3 Phase, 380 V, 50 Hz					
	Colour		Ivory White					
	Air flow rate (H)		78		120		166	
			2,750		4,240		5,860	
	External static pressure ⁴		30		150			
	Fan		Motor output		1.5		2.2	
			Drive		Belt Drive			
	Dimensions (H×W×D)		500×1,330×850		625×1,980×850		760×2,195×870	
	Machine weight		106		187		216	
	Sound level		37		39		60	
Drain		PS 3/4B Internal thread		PS 1B Internal Thread				
Outdoor unit	Power supply		3 Phase, 380 V, 50 Hz					
	Colour		Ivory white					
	Compressor		type		Hermetically sealed scroll type			
			Motor output		3.2x1		4.5x1	
					(3.5x1)+(3.5x1)		(4.9x1)+(4.2x1)	
					Micro Channel			
					Cross fin coil			
	Air flow rate (H)		126		178		257	
			1,260		1,780		2,570	
	Dimensions (H×W×D)		870×1,100×460		1,657×930×765		1,657×1,240×765	
Machine weight		113		185		291		
Sound level ⁵		61		57		65		
Operation range		10 to 49						
Refrigerant charge		3.8		6.7		8.2		
Liquid		mm		Ø 9.5 (Brazing)		Ø 12.7 (Brazing)		
Gas		mm		Ø 19.1 (Brazing)		Ø 22.2 (Brazing)		
Max. piping length		70 (equivalent length 90 m)						
Max. level difference		50 ⁴		50				
Safety Device		High Pressure Switch, Fan Driver Overload Protector, Inverter Overload Protector, Fuse, Bimetal thermostat (Overload Relay)						

Note: ¹ Indoor temp.: 27°C DB, 19°C WB / outdoor temp.: 35°C DB, 24°C WB / Equivalent piping length: 7.5 m, level difference: 0 m

² Anechoic chamber conversion value, measured at a point 1 m in front of the unit at a height of 1.5 m.

During actual operation, these values are normally somewhat higher as a result of ambient conditions and oil recovery mode.

When there is concern for noise the surrounding area such as residences, we recommend investigating the installation location and taking soundproofing measures.

³ The value is the external static pressure with standard pulley.

⁴ Max. 40 m if the outdoor unit is lower than the indoor unit.

⁵ Capacity are net, including a deduction for cooling for indoor fan motor heat.

Option

FLOOR STANDING TYPE

Option	Direct Air Blow	Duct Connection		
	FVGR-PV25R1	FVPR10QY2S	FVPR12/16QY2S	FVPR18/20QY2S
Discharge grill plenum chamber (Including pulley and belt)	—	BPCV10Q	BPCV16Q	BPCV20Q
Filter chamber	—	BFUIB250	BFUIB400	BFUIB500

DUCT TYPE

Option	FDR08OY2S	FDR10OY2S	FDR12OY2S	FDR16OY2S	FDR18OY2S	FDR20OY2S
Discharge grill plenum chamber (Including pulley and belt)	BPCD10Q		BPCD16Q		BPCD20Q	

CONTROL SYSTEM

Option	FVGR-PV25R1	FVPR-QY2S	FDR-QY2S
Simplified remote controller	BRCIC62-9 (Built-in)	BRC2E61 (Built-in)	BRC2E61
Navigator remote controller	—	BRCIE63	
Intelligent touch controller	—	DCS601C51	
Central remote controller	—	DCS302CA61	
Unified ON/OFF controller	—	DCS301B61	
Schedule timer	—	DST301BA61	
Wiring adaptor for electrical appendices (Group control adaptor)★	—	KRP4AA51	
Wiring adaptor for electrical appendices★	—	KDD2AA61	
Adaptor for wiring★	KRP1C67	—	
Adaptor for wiring (operation status output)★	BRP11B61	—	
Remote sensor (for indoor temperature)	BRC501A-1	BRC501A-6	
Mounting plate for adaptor PCB★	—	BRP20A-3	BRP20A-2

Note: Mounting plate★ is necessary for each adaptor marked A.

Dimensions (Unit:mm)

FLOOR STANDING TYPE

DIRECT AIR BLOW

FVGR08PV2SR1
FVGR10PV2SR1

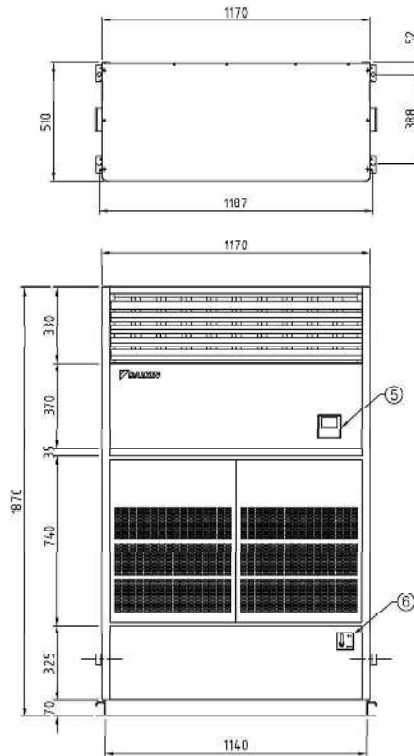

- ① Liquid pipe conn. ϕ 9.52 C1220T brazing
- ② Gas pipe conn. :
 ϕ 19.1 C1220T brazing for FVGR08PV2SR1
 ϕ 22.2 C1220T brazing for FVGR10PV2SR1
- ③ Upper drain outlet (PS 1R Internal thread)
- ④ Power supply & control wire intake
- ⑤ Digital remote controller
- ⑥ Toggle switch for FAN SPEED Hi/LOW

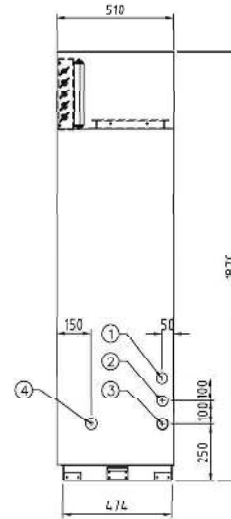

SDR3150215A

DUCT CONNECTION

FVPR10QY2S

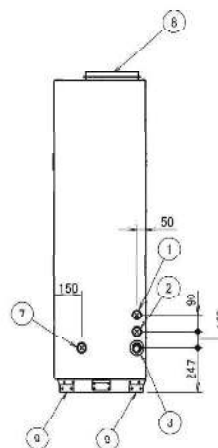
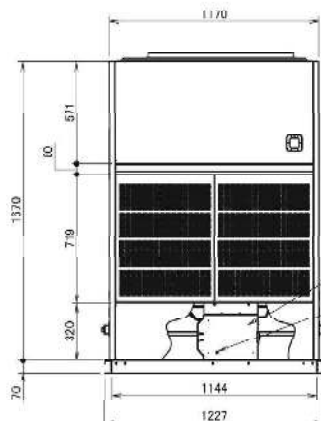
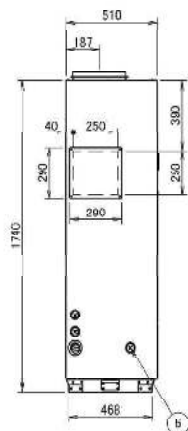
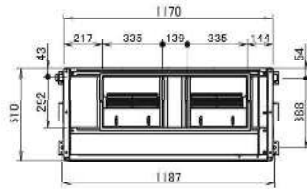

SERVICE SPACE NOTE 1)

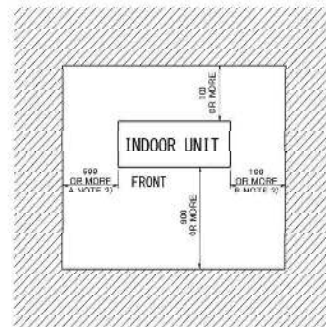

NOTE 1) IT IS SHOWN IN CASE OF LEFT SIDE PIPING.
(FACTORY DEFAULT IS LEFT SIDE PIPING)
CHANGE TO RIGHT SIDE PIPING NEEDS FIELD WORK.
2) REVERSE DIMENSION A TO B IN CASE OF RIGHT SIDE PIPING.

FOUNDATION BOLT		FOR M12 BOLT	
9	FOUNDATION BOLT		
8	AIR DISCHARGE FLANGE		
7	TRANSMISSION WIRING CONNECTION		
6	POWER SUPPLY WIRING CONNECTION		
5	CONTROL BOX		
4	EARTH TERMINAL (TERMINAL IN CONTROL BOX)		M4
0	DRAIN PIPE CONNECTION		FD 10: INTERNAL THREAD
2	GAS PIPE CONNECTION		ϕ 22.2
1	LIQUID PIPE CONNECTION		ϕ 9.5
ITEM	PART NAME		RE-MARK

3D147290A

DUCT CONNECTION

FVPR12QY2S
FVPR16QY2S

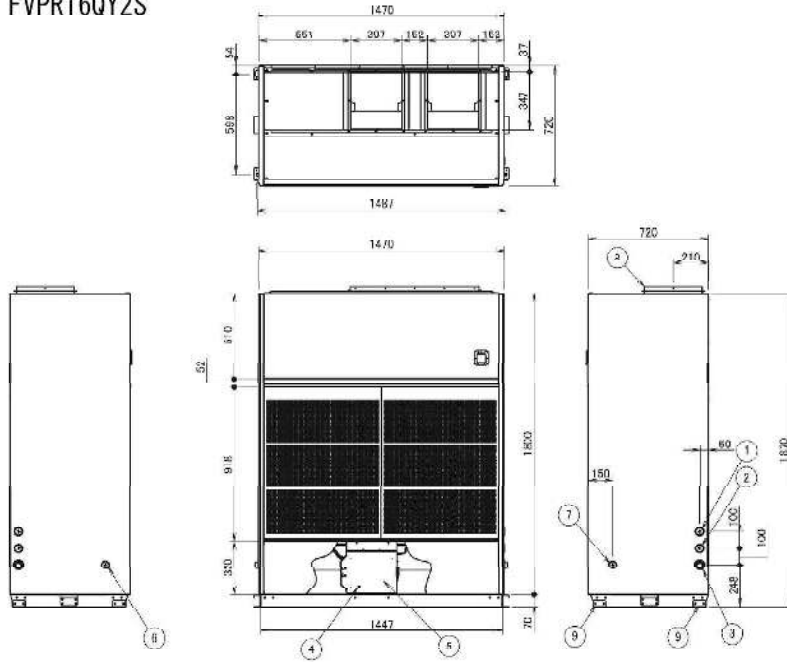

SERVICE SPACE NOTE 1)

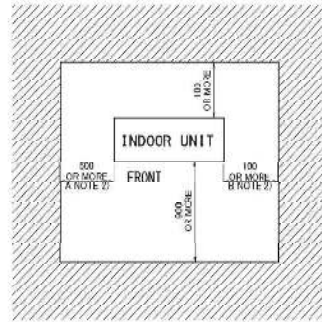

NOTE 1) IT SHOWS IN CASE OF LEFT SIDE PIPING.
(FACTORY DEFAULT IS LEFT SIDE PIPING.)
CHANGE TO RIGHT SIDE PIPING NEEDS FIELD WORK.)
2) REVERSE DIMENSION A TO B IN CASE OF RIGHT SIDE PIPING.

ITEM	PART NAME	REMARK
9	FOUNDATION BOLT	FOR M12 BOLT
8	AIR DISCHARGE FLANGE	
7	TRANSMISSION WIRING CONNECTION	
6	POWER SUPPLY WIRING CONNECTION	
5	CONTROL BOX	
4	EARTH TERMINAL (TERMINAL IN CONTROL BOX)	M4
3	DRAIN PIPE CONNECTION	PS 1/8 INTERNAL THREAD
2	GAS PIPE CONNECTION	φ 20.6
1	LIQUID PIPE CONNECTION	φ 12.7

3D147291A

DUCT CONNECTION

FVPR18QY2S
FVPR20QY2S

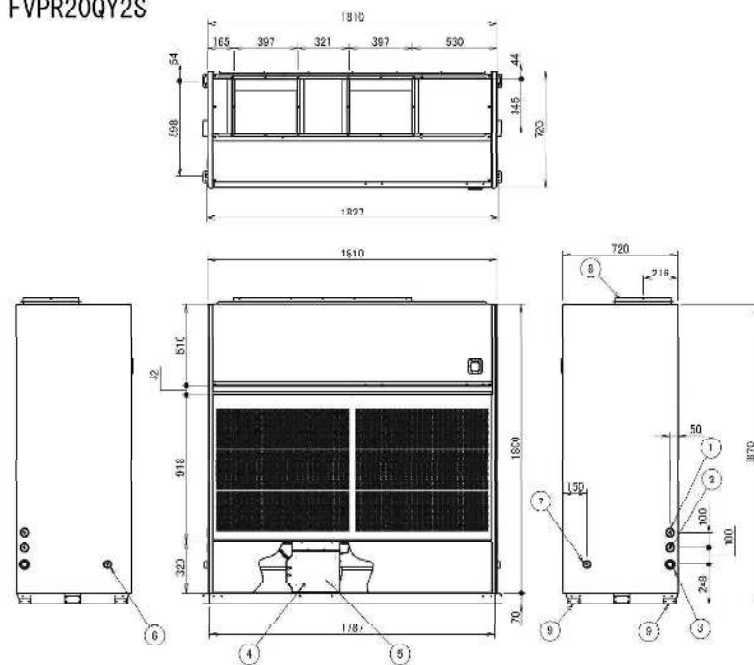

SERVICE SPACE NOTE 1)

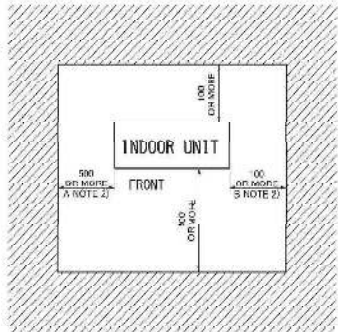

NOTE 1) IT SHOWS IN CASE OF LEFT SIDE PIPING.
(FACTORY DEFAULT IS LEFT SIDE PIPING.)
CHANGE TO RIGHT SIDE PIPING NEEDS FIELD WORK.)
2) REVERSE DIMENSION A TO B IN CASE OF RIGHT SIDE PIPING.

ITEM	PART NAME	REMARK
9	FOUNDATION BOLT	FOR M12 BOLT
8	AIR DISCHARGE FLANGE	
7	TRANSMISSION WIRING CONNECTION	
6	POWER SUPPLY WIRING CONNECTION	
5	CONTROL BOX	
4	EARTH TERMINAL (TERMINAL IN CONTROL BOX)	M4
3	DRAIN PIPE CONNECTION	PS 1/8 INTERNAL THREAD
2	GAS PIPE CONNECTION	φ 28.6
1	LIQUID PIPE CONNECTION	φ 15.9

3D147292A

Dimensions (Unit:mm)

OUTDOOR UNIT

RZUR08/10PY2S

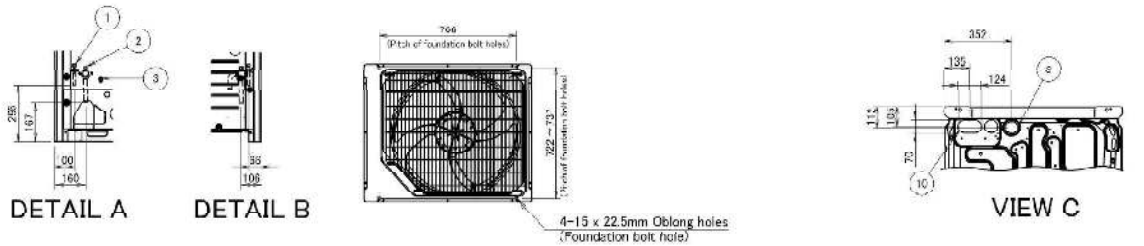

DETAIL A

DETAIL B

VIEW C

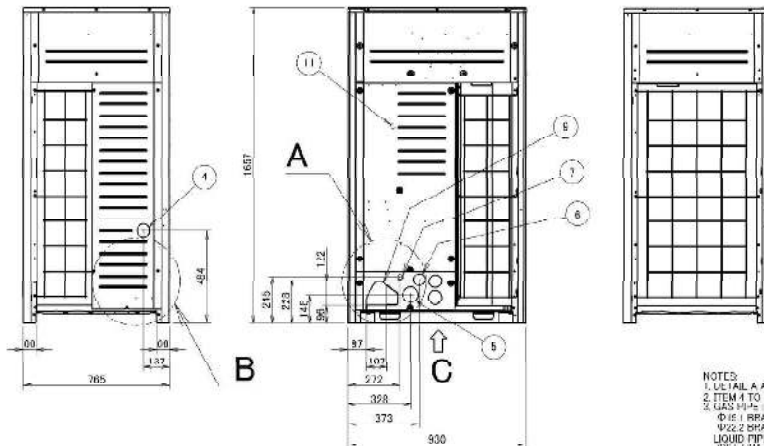

No.	Parts name	Dimension
1	Liquid pipe connection port	See note 5.
2	Gas pipe connection port	See note 5.
3	Refrigerant charge port	
4	Power supply main cable hole (top)	Φ65
5	Power cord routing hole (front)	Φ50
6	Power cord routing hole (rear)	Φ65
7	Transmission wire routing hole (front)	Φ67
8	Power cord routing hole (bottom)	Φ68
9	Pipe routing hole (side)	
10	Flare connection hole (bottom)	
11	Grounding terminal	Inside of switch box (M5)

NOTES:
 1. DETAIL A AND DETAIL B INDICATE THE DIMENSIONS AT INSTALLING THE AIR FILTERS.
 2. ITEM 4 TO 10 KNOCK OUT HOLE.
 3. (M5) Φ1.6
 Φ15.1 BRAZING CONNECTION : RZUR08PY14, RZUR08PY2S
 Φ22.2 BRAZING CONNECTION : RZUR08PY14, RZUR10PY2S
 LIQUID PIPE :
 Φ6.3 BRAZING CONNECTION : RZUR08/10PY14, RZUR08/10PY2S

3D129057

RZUR08QY2S

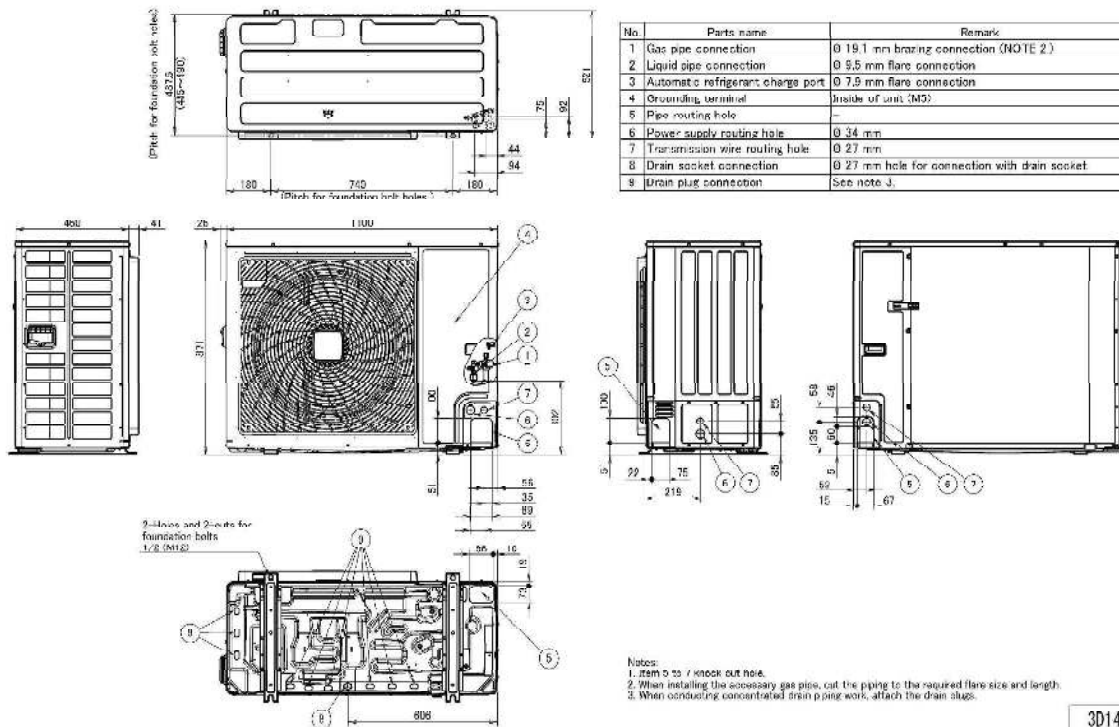

No.	Parts name	Remark
1	Gas pipe connection	Φ 19.1 mm brazing connection (NOTE 2)
2	Liquid pipe connection	Φ 5.5 mm flare connection
3	Automatic refrigerant charge port	Φ 7.9 mm flare connection
4	Grounding terminal	Inside of unit (M5)
5	Pipe routing hole	
6	Power supply routing hole	Φ 34 mm
7	Transmission wire routing hole	Φ 27 mm
8	Drain socket connection	Φ 27 mm hole for connection with drain socket
9	Drain plug connection	See note 3.

Notes:
 1. Item 5 to 7 knock out hole.
 2. When installing the necessary gas pipe, cut the piping to the required flare size and length.
 3. When conducting concentrated drain pipe work, attach the drain plugs.

3D147199

RZUR10QY2S

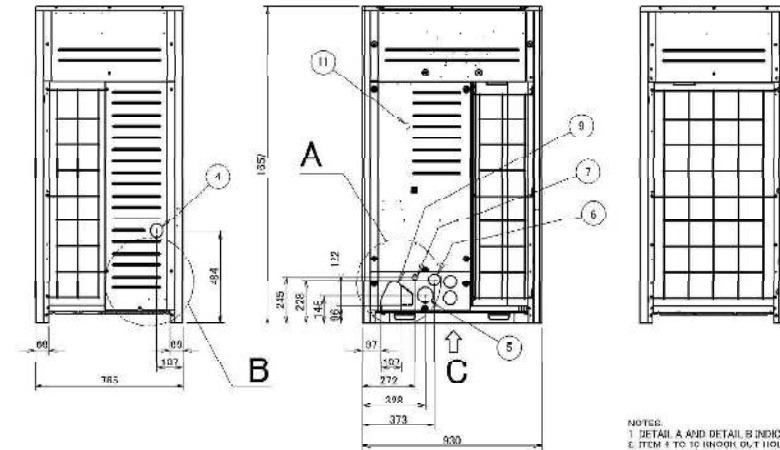
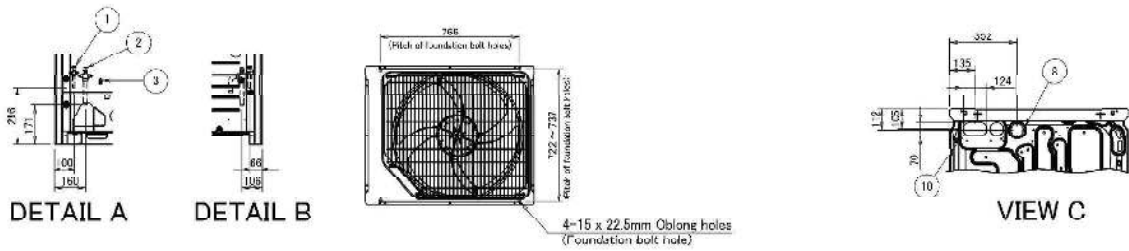

No.	Part name	Remark
1	Liquid pipe connection port	See note 2
2	Gas pipe connection port	See note 3
3	Refrigerant charge port	
4	Power cord routing hole (side)	Φ65
5	Power cord routing hole (front)	Φ80
6	Power cord routing hole (front)	Φ80
7	Transmission wire routing hole (front)	Φ27
8	Power cord routing hole (bottom)	Φ45
9	Pipe routing hole (front)	
10	Pipe routing hole (bottom)	
11	Grounding terminal	Inside of switch box (MB)

NOTE:
 1. DETAIL A AND DETAIL B INDICATE THE DIMENSIONS AFTER FIXING THE ATTACHED PIPING.
 2. ITEM 4 TO 10 INDICATE THE HOLE.
 3. GAS PIPE : Φ22.5 BRAZING CONNECTION
 LIQUID PIPE : Φ25.5 BRAZING CONNECTION

3D147200

RZUR12/16/18/20QY2S

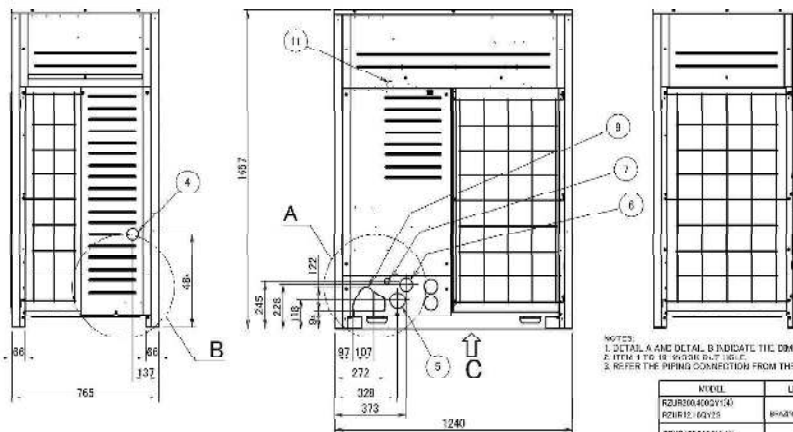
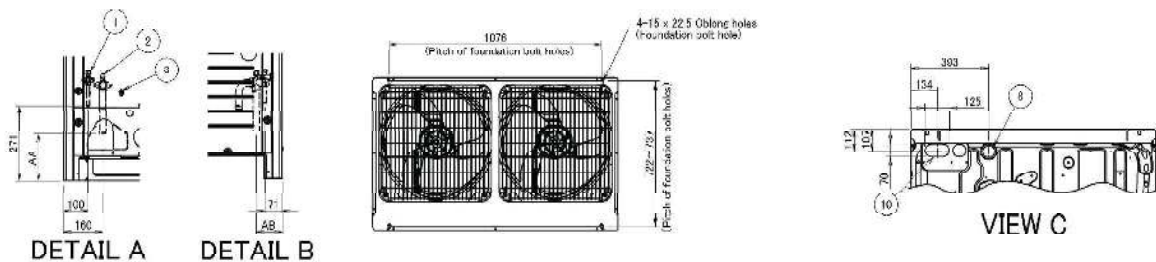

Model	AX	AB
RZUR12QY2S	171	165
RZUR16/18/20QY2S	181	101

No.	Parts name	Remark
1	Liquid pipe connection port	See note 2
2	Gas pipe connection port	See note 3
3	Refrigerant charge port	
4	Power cord routing hole (side)	Φ65
5	Power cord routing hole (front)	Φ80
6	Power cord routing hole (front)	Φ80
7	Transmission wire routing hole (front)	Φ27
8	Power cord routing hole (bottom)	Φ45
9	Pipe routing hole (front)	
10	Pipe routing hole (bottom)	
11	Grounding terminal	Inside of switch box (MB)

NOTE:
 1. DETAIL A AND DETAIL B INDICATE THE DIMENSIONS AFTER FIXING THE ATTACHED PIPING.
 2. ITEM 4 TO 10 INDICATE THE HOLE.
 3. REFER THE PIPING CONNECTION FROM THE TABLE BELOW.

MODEL	LIQUID PIPE	GAS PIPE
RZUR12/16/18/20QY2S	Φ22.5 BRAZING CONNECTION	Φ25.5 BRAZING CONNECTION
RZUR12/16/18/20QY2S	Φ25.5 BRAZING CONNECTION	Φ22.5 BRAZING CONNECTION

3D147202

Space required for indoor unit installation (Unit:mm)

FVGR08PV2SR1
FVGR10PV2SR1

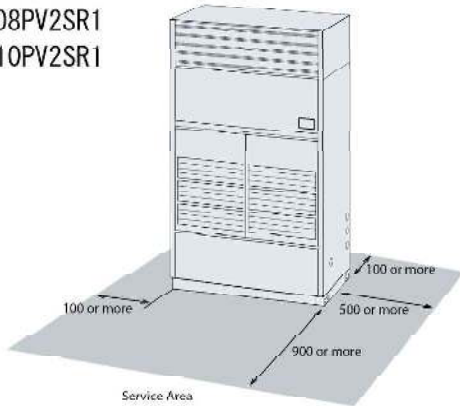

FVPR10QY2S
FVPR12QY2S
FVPR16QY2S
FVPR18QY2S
FVPR20QY2S

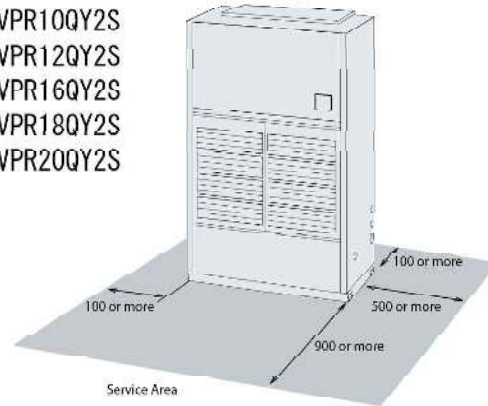

FDR08QY2S
FDR10QY2S

Provide enough clearance between the unit and the surrounding walls to prevent contact.

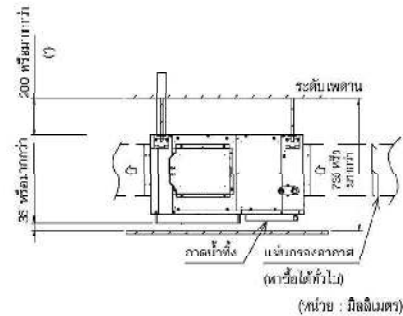
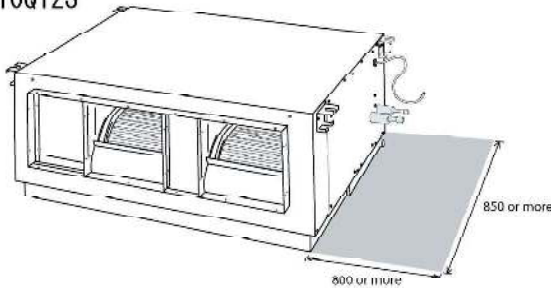

FDR12QY2S
FDR16QY2S

Provide enough clearance between the unit and the surrounding walls to prevent contact.

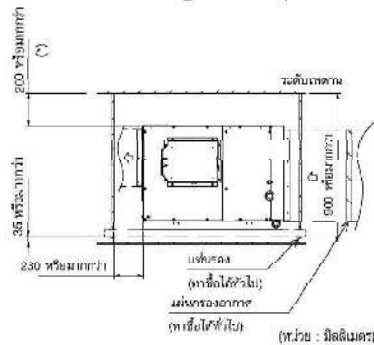
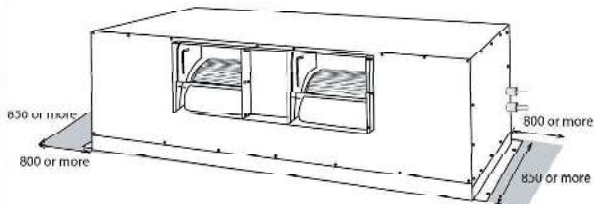

FDR18QY2S
FDR20QY2S

Provide enough clearance between the unit and the surrounding walls to prevent contact.

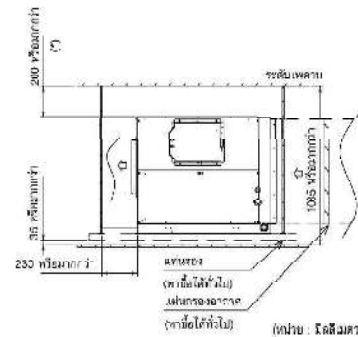
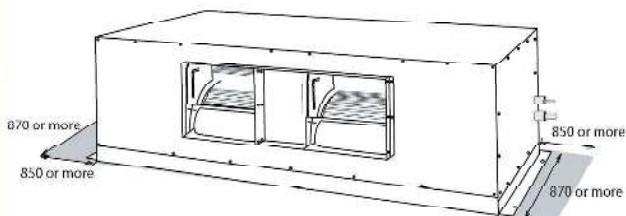

Space required for outdoor unit installation (Unit:mm)

RZUR08PY2S / RZUR10PY2S / RZUR10QY2S / RZUR12QY2S / RZUR16QY2S / RZUR18QY2S / RZUR20QY2S

For single unit installation

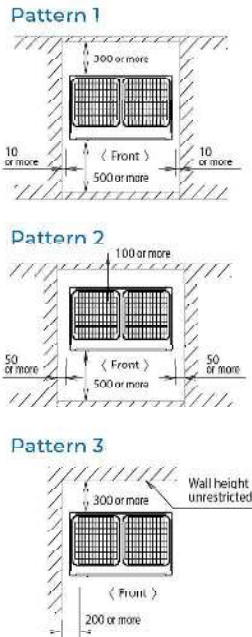

For installation in rows

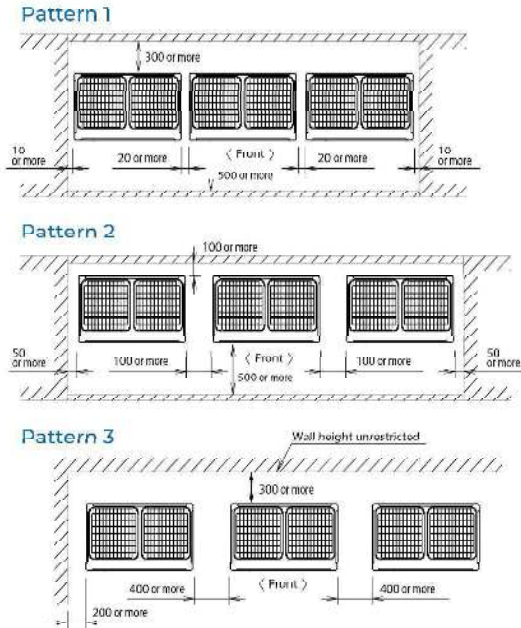

For centralized group layout



Notes: 1. Heights of walls in case of Patterns 1 and 2:

Front: 1500 mm

Suction side: 2000 mm

Side: Height unrestricted.

The installation space to be shown in this drawing is based on the cooling operation at 35 degrees outdoor air temperature. When the outdoor operation air temperature exceeds 35 degrees or the load exceeds the rated capacity, the unit should be installed on a level surface.

2. If the above wall heights are exceeded then h/2 and h/2 should be added to the front and suction side service spaces respectively as shown in the figure on the right.

3. When installing the units most appropriate pattern should be selected from those shown above in order to obtain the best fit in the space available always bearing in mind the need to leave enough space for a person to pass between units and wall and for the air to circulate freely.

If more units are to be installed then care for in the above patterns your layout should take account of the possibility of short circuits!

4. The units should be installed to leave sufficient space at the front for the on site refrigerant piping work to be carried out comfortably.

(Unit : mm)

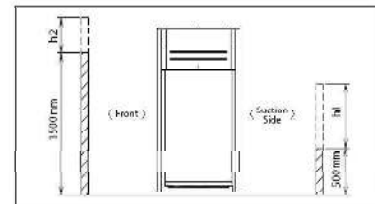

Discharge grill Plenum Chamber

FLOOR STANDING TYPE

BPCV10Q

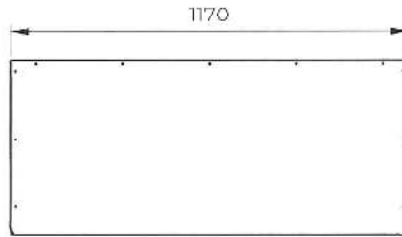
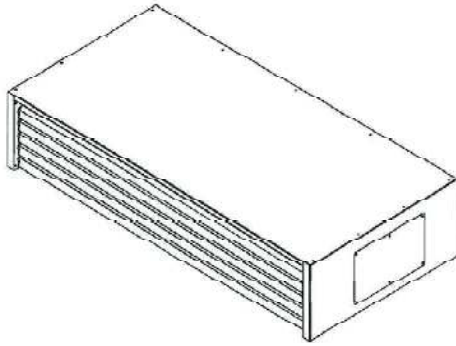

Top View



Front View

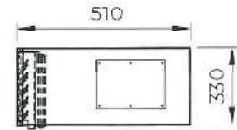

Side View

BPCV16Q

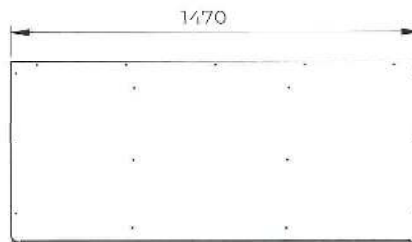
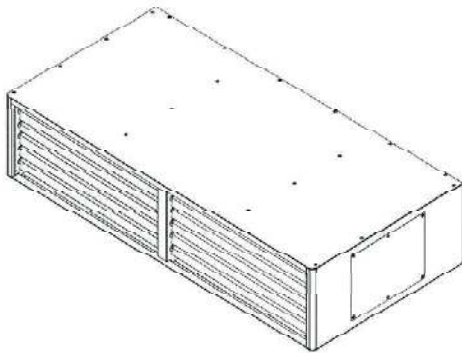

Top View



Front View

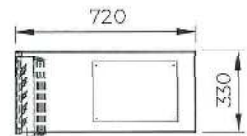

Side View

BPCV20Q

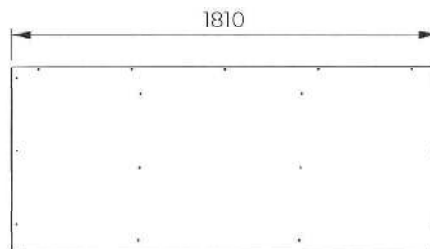
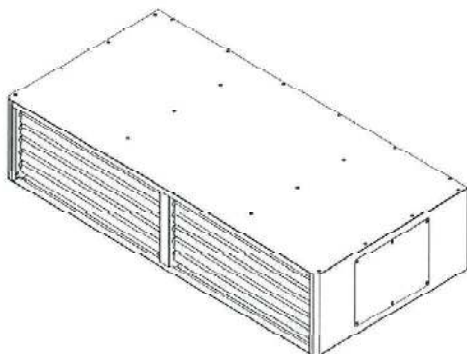

Top View

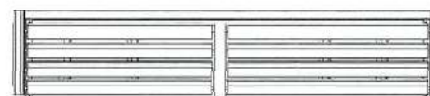

Front View

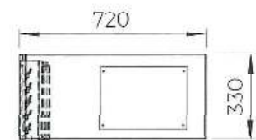

Side View

Space required for outdoor unit installation (Unit:mm)

DUCT TYPE

BPCD10Q

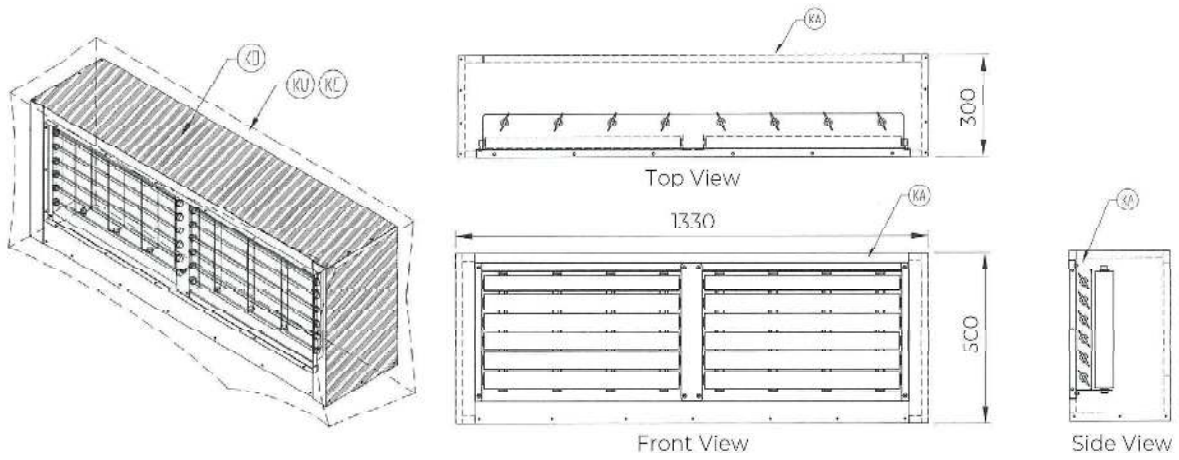

BPCD16Q

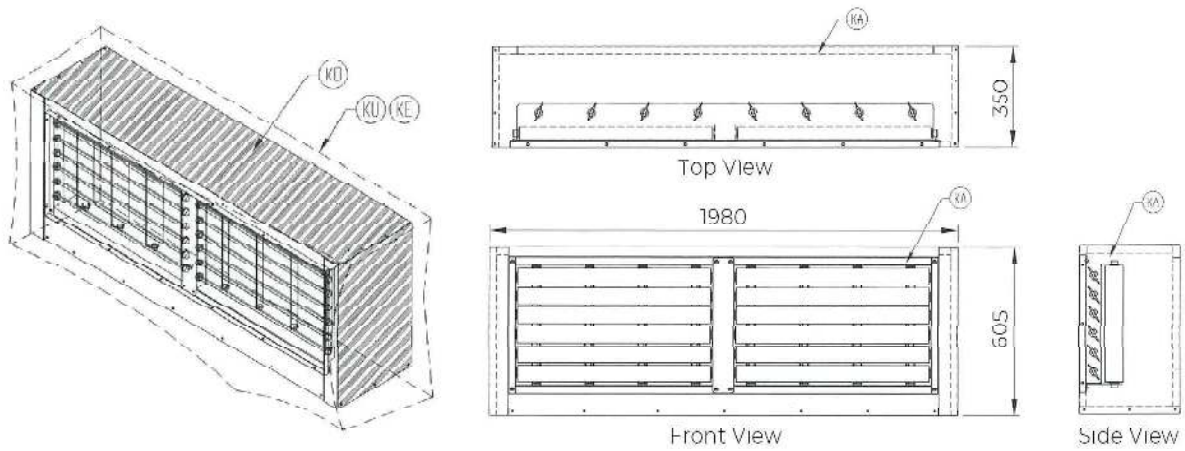

BPCD20Q

